

# MRR RTS + Smoove Origin RTS

**FR** NOTICE

**EN** INSTRUCTIONS

**IT** MANUALE

**ES** MANUAL

**PT** INSTRUÇÕES

**EL** ΕΓΧΕΙΡΙΔΙΟ

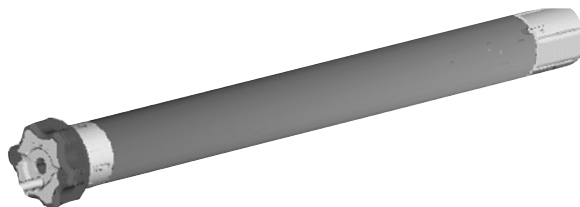

Ref. 5137351A



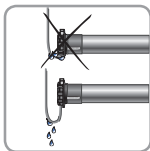

## FR

## NOTICE ORIGINALE

Cette notice s'applique à toutes les motorisations MRR RTS dont les déclinaisons sont disponibles au catalogue en vigueur.

**Domaine d'application**

Les motorisations MRR sont conçues pour motoriser tous types de volets roulants.

L'installateur, professionnel de la motorisation et de l'automatisation de l'habitat doit s'assurer que l'installation du produit motorisé une fois installé respecte les normes en vigueur dans le pays de mise en service comme notamment la norme sur les volets roulant EN13659.

**Responsabilité**

Avant d'installer et d'utiliser la motorisation, lire attentivement cette notice. Outre les instructions décrites dans cette notice, respecter également les consignes détaillées dans le document joint **Consignes de sécurité**.







La motorisation doit être installée par un professionnel de la motorisation et de l'automatisation de l'habitat, conformément aux instructions de Somfy et à la réglementation applicable dans le pays de mise en service.

Toute utilisation de la motorisation hors du domaine d'application décrit ci-dessus est interdite. Elle exclurait, comme tout irrespect des instructions figurant dans cette notice et dans le document joint **Consignes de sécurité**, toute responsabilité et garantie de Somfy.

L'installateur doit informer ses clients des conditions d'utilisation et de maintenance de la motorisation et doit leur transmettre les instructions d'utilisation et de maintenance, ainsi que le document joint **Consignes de sécurité**, après l'installation de la motorisation. Toute opération de Service Après-Vente sur la motorisation nécessite l'intervention d'un professionnel de la motorisation et de l'automatisation de l'habitat.

Si un doute apparaît lors de l'installation de la motorisation ou pour obtenir des informations complémentaires, consulter un interlocuteur Somfy ou aller sur le site [www.somfy.com](http://www.somfy.com).

**Consignes particulières de sécurité**

-  Respecter la Norme NF C 15-100 pour les installations électriques.
-  Les câbles traversant une paroi métallique doivent être protégés et isolés par un manchon ou un fourreau.
-  Attacher les câbles pour éviter tout contact avec une partie en mouvement.
-  Si la motorisation est utilisée en extérieur, et si le câble d'alimentation est de type H05-VVF, alors installer le câble dans un conduit résistant aux UV, par exemple sous goutlotte.
-  Laisser le câble d'alimentation de la motorisation accessible : il doit pouvoir être remplacé facilement.
-  Toujours faire une boucle sur le câble d'alimentation pour éviter la pénétration d'eau dans la motorisation!



Pour les moteurs tubulaires de Ø 50/60 mm :

La roue doit être bloquée en translation dans le tube d'enroulement :

- Soit en fixant le tube d'enroulement sur la roue à l'aide de 4 vis ou 4 rivets pop placés entre 5 mm et 15 mm de l'extrémité extérieure de la roue, quel que soit le tube d'enroulement. Les vis ou les rivets pop ne doivent pas être fixés sur la motorisation mais uniquement sur la roue.
- Soit par l'utilisation d'un stop roue, pour les tubes non lisses.



These instructions apply to all MRR RTS drive, the different versions of which are available in the current catalogue.

### Field of application

MRR drives are designed to drive all types of roller shutters.

The installer, who must be a motorisation and home automation professional, must ensure that the motorised product is installed in accordance with the standards in force in the country in which it is installed such as EN 13659 relating to roller shutters.

### Liability

Please read these instructions carefully before installing and using the drive. In addition to following the instructions given in this guide, the instructions detailed in the attached **Safety instructions** document must also be observed.

The drive must be installed by a motorisation and home automation professional, according to instructions from Somfy and the regulations applicable in the country in which it is commissioned.

It is prohibited to use the drive outside the field of application described above. Such use, and any failure to comply with the instructions given in this guide and in the attached **Safety instructions** document, absolves Somfy of any liability and invalidates the warranty.

The installer must inform its customers of the operating and maintenance conditions for the drive and must provide them with the instructions for use and maintenance, and the attached **Safety instructions** document, after installing the drive. Any After-Sales Service operation on the drive must be performed by a motorisation and home automation professional.

If in doubt when installing the drive, or to obtain additional information, contact a Somfy adviser or go to the website [www.somfy.com](http://www.somfy.com).

### Specific safety instructions



Cables which pass through a metal wall must be protected and isolated using a sheath or sleeve.



Attach cables to prevent any contact with moving parts.



If the drive is used outdoors, and if the power supply cable is a type H05-VVF cable, the cable should be installed in a UV-resistant duct, e.g. under a gland.



Leave the drive power supply cable accessible: it must be possible to replace it easily.



Always make a loop in the power supply cable to prevent water entering the drive.



For tubular motors 50/60 mm in diameter:

The drive wheel must be locked in place to prevent it moving along the roller tube:

- Either by securing the roller tube onto the drive wheel using 4 screws or 4 pop rivets positioned between 5 mm and 15 mm from the outer edge of the drive wheel, suitable for all types of roller tube. The screws or pop rivets must only be attached to the drive wheel and not to the drive.

- Or by using a drive wheel stop, suitable for tubes which are not smooth.

Il presente manuale si applica a tutte le motorizzazioni MRR RTS le cui versioni sono disponibili nel catalogo vigente.

### Settore di applicazione

Le motorizzazioni MRR sono progettate per motorizzare tutti i tipi di tapparelle in commercio.

L'installatore, professionista della motorizzazione e dell'automazione d'interni, deve accertarsi che l'installazione del prodotto motorizzato rispetti le norme in vigore nel paese di messa in servizio come, nello specifico, la normativa sulle tapparelle EN13659.

### Responsabilità

Prima di installare e di utilizzare la motorizzazione, leggere attentamente questo manuale. Oltre le istruzioni riportate nel presente manuale, rispettare altresì le istruzioni elencate nel documento annesso **Istruzioni di sicurezza**.

La motorizzazione deve essere installata da un professionista della motorizzazione e dell'automazione d'interni, conformemente alle istruzioni di Somfy e alle normative applicabili nel paese di messa in servizio.

Ogni utilizzo della motorizzazione al di fuori dell'ambito di applicazione descritto sopra è vietato. Esso escluderebbe, così come il mancato rispetto delle istruzioni riportate nel presente manuale e nel documento annesso **Istruzioni di sicurezza**, ogni responsabilità e garanzia di Somfy.

L'installatore deve informare i suoi clienti in relazione alle condizioni d'uso e di manutenzione della motorizzazione e deve consegnare loro le istruzioni d'uso e di manutenzione, oltre al documento allegato **Istruzioni di sicurezza**, dopo l'installazione della motorizzazione. Qualsiasi operazione di assistenza clienti sulla motorizzazione richiede l'intervento di un professionista di impianti di motorizzazione e di domotica.

In caso di dubbi durante l'installazione della motorizzazione o per avere maggiori informazioni, consultare un interlocutore Somfy o visitare il sito [www.somfy.com](http://www.somfy.com).

### Istruzioni di sicurezza particolari



I cavi che passano attraverso una parete metallica devono essere protetti ed isolati da un manicotto o una guaina.



Fissare i cavi per evitare il contatto con parti in movimento.



Se la motorizzazione viene utilizzata all'esterno e se il cavo di alimentazione è di tipo H05-VVF, installare il cavo in un condotto resistente ai raggi UV, ad esempio sotto una canalina passacavi.



Lasciare libero l'accesso al cavo d'alimentazione della motorizzazione: deve poter essere sostituito facilmente.



Creare sempre un doppino sul cavo di alimentazione per evitare infiltrazioni di acqua all'interno della motorizzazione!



Per i motori tubolari Ø 50/60 mm:

La ruota deve essere bloccata in traslazione nel tubo di avvolgimento:

- O fissando il tubo di avvolgimento sulla ruota per mezzo di 4 viti o 4 rivetti in acciaio posizionati tra 5 mm e 15 mm dall'estremità esterna della ruota, indipendentemente dal tipo di tubo di avvolgimento. Le viti o rivetti non devono essere fissati sulla motorizzazione ma esclusivamente sulla ruota.

- O mediante l'uso di un bloccaruota, per i tubi non lisci.

## ES

## MANUAL TRADUCIDO

Este manual es aplicable a todas las motorizaciones MRR RTS cuyas versiones se encuentran disponibles en el catálogo en vigor.

**Ámbito de aplicación**

Las motorizaciones MRR han sido diseñadas para automatizar todo tipo de persianas enrollables. El instalador, profesional de la motorización y de la automatización de la vivienda, debe asegurarse de que la instalación del producto automatizado, una vez instalado, respete las normas vigentes en el país donde vaya a utilizarse, en particular, la norma sobre persianas enrollables EN 13659.

**Responsabilidad**

Antes de instalar y utilizar la motorización, lea atentamente este manual. Además de las instrucciones descritas en este manual, deben respetarse las normas detalladas en el documento adjunto **Normas de seguridad**.

La motorización debe ser instalada por un profesional de la motorización y de la automatización de la vivienda, de conformidad con las instrucciones proporcionadas por Somfy y con la normativa aplicable en el país donde vaya a utilizarse.

Se prohíbe cualquier uso de la motorización fuera del ámbito de aplicación anteriormente descrito. Ello conllevaría, al igual que cualquier incumplimiento de las instrucciones que figuran en este manual y en el documento adjunto **Normas de seguridad**, la exclusión de toda responsabilidad por parte de Somfy y la anulación de la garantía.

El instalador debe informar a sus clientes acerca de las condiciones de uso y de mantenimiento de la motorización y debe entregarles las instrucciones de uso y de mantenimiento, así como el documento adjunto **Normas de seguridad**, tras la instalación de la motorización. Cualquier operación de Servicio Posventa en la motorización requerirá la intervención de un profesional de la motorización y la automatización de la vivienda.

Para resolver cualquier duda que pudiera surgir durante la instalación de la motorización o para obtener información adicional, póngase en contacto con uno de los agentes de Somfy o visite la página web [www.somfy.com](http://www.somfy.com).

**Normas particulares de seguridad**

 En caso de que los cables deban atravesar una pared metálica, deben protegerse y aislarse con un manguito o una vaina.

 Fije los cables para evitar cualquier contacto con un componente en movimiento.

 Si la motorización va a utilizarse en el exterior, y siempre que el cable de alimentación sea de tipo H05-VVF, instale el cable en un conducto resistente a los rayos UV, por ejemplo, en el interior de una canalleta.

 Deje accesible el cable de alimentación del motor: debe poder ser sustituido fácilmente.

 Efectúe siempre un bucle en el cable de alimentación para evitar que penetre agua en el motor.

 En el caso de los motores tubulares de Ø 50/60 mm:  
El movimiento de traslación de la rueda debe quedar bloqueado dentro del tubo de enrollamiento:  
- Fijando el tubo de enrollamiento a la rueda con cuatro tornillos o cuatro remaches Pop colocados a entre 5 mm y 15 mm del extremo exterior de la rueda, sea cual sea el tipo de tubo de enrollamiento utilizado. Los tornillos o los remaches Pop no deben fijarse al motor, sino únicamente a la rueda.  
- Mediante un dispositivo de retención de rueda, en caso de los tubos no lisos.

## PT

## INSTRUÇÕES TRADUZIDAS

Estas instruções aplicam-se a todos os motores MRR RTS cujas variantes estão disponíveis no catálogo em vigor.

**Área de aplicação**

Os motores MRR foram concebidos para motorizar todos os tipos de estores.

O instalador, profissional da motorização e da automatização do lar deve assegurar-se de que a instalação do produto motorizado, depois de instalado, respeita as normas em vigor no país de colocação em serviço, tais como a norma sobre os estores EN13659.

**Responsabilidade**

Antes de instalar e de utilizar o motor, ler atentamente estas instruções. Tal como acontece com as instruções descritas nestas instruções, também devem ser respeitadas as instruções detalhadas apresentadas no documento em anexo **Instruções de segurança**.

O motor deve ser instalado por um profissional da motorização e da automatização do lar, em conformidade com as instruções da Somfy e a regulamentação do país no qual é instalado.

Qualquer utilização do motor fora da área de aplicação acima descrita é proibida. Tal utilização excluiria, como qualquer desrespeito pelas instruções constantes deste guia e no documento em anexo **Instruções de segurança**, toda a responsabilidade e garantia da Somfy.

O técnico de instalação deve informar os seus clientes sobre as condições de funcionamento e de manutenção do motor e deve comunicar-lhes as instruções de utilização e de manutenção, bem como o documento em anexo **Instruções de segurança**, após a instalação do motor. Todas as operações do Serviço Pós-Venda no motor requerem a intervenção de um profissional da motorização e da automatização do lar.

Em caso de dúvidas aquando da instalação do motor ou para obter informações complementares, consultar um interlocutor Somfy ou o site [www.somfy.com](http://www.somfy.com).

**Instruções específicas de segurança**

 Os cabos que atravessam uma parede metálica devem ser protegidos e isolados por uma manga ou um forro.

 Prender os cabos para evitar um eventual contacto com uma parte móvel.

 Se o motor for utilizado no exterior e se o cabo de alimentação for do tipo H05-VVF, o cabo deve ser instalado dentro de uma conduta resistente aos UV, por exemplo sob uma manga de protecção.

 Deixar o cabo de alimentação do motor em posição acessível: deve poder ser facilmente substituído.

 Fazer sempre um arco no cabo de alimentação, para evitar a entrada de água no motor!

 Para os motores tubulares de Ø 50/60 mm:

A roda de tracção deve ser bloqueada em translação, dentro do tubo de enrolamento:  
- Fixando o tubo de enrolamento à roda de tracção com 4 parafusos ou 4 rebites, colocados entre 5 mm e 15 mm da extremidade exterior da roda de tracção, qualquer que seja o tubo de enrolamento.  
Os parafusos ou os rebites não devem ser fixos ao motor, mas apenas à roda de tracção.  
- Ou utilizando um bloqueador de roda, no caso dos tubos não lisos.

Το παρόν εγχειρίδιο ισχύει για όλους τους μηχανισμούς MRR RTS οι παραλλαγές των οποίων είναι διαθέσιμες στον ισχύοντα κατάλογο.

### Πεδίο εφαρμογής

Οι μηχανισμοί MRR σχεδιάστηκαν για να εφοδιάζουν με ηλεκτροκίνηση όλους τους τύπους ρολών.

Ο τεχνικός εγκατάστασης, επαγγελματίας με γνώσεις στους μηχανισμούς και αυτοματισμούς κατοικιών, οφείλει να διασφαλίσει ότι η εγκατάσταση του ηλεκτροκίνητου προϊόντος ανταποκρίνεται στα πρότυπα που ισχύουν στη χώρα στην οποία τίθεται σε λειτουργία, και κυρίως στο πρότυπο EN 13659 για τα ρολά.

### Ευθύνη

Πριν από την εγκατάσταση και τη χρήση του μηχανισμού, διαβάστε προσεκτικά το παρόν εγχειρίδιο. Εκτός από τις οδηγίες που περιγράφονται στο παρόν εγχειρίδιο, τηρήστε επίσης τις οδηγίες που αναφέρονται αναλυτικά στο συνημμένο έγγραφο **Οδηγίες ασφαλείας**.

Ο μηχανισμός πρέπει να εγκαθίσταται από επαγγελματία με γνώσεις στους μηχανισμούς και αυτοματισμούς κατοικιών, σύμφωνα με τις οδηγίες της Somfy και τους ισχύοντες κανονισμούς της χώρας στην οποία τίθεται σε λειτουργία.

Απαγορεύεται οποιαδήποτε χρήση του μηχανισμού πέραν του πεδίου εφαρμογής που περιγράφεται πιο πάνω. Οποιαδήποτε άλλη χρήση καθώς και η μη τήρηση των οδηγιών που αναφέρονται στο παρόν εγχειρίδιο και στο συνημμένο έγγραφο **Οδηγίες ασφαλείας** συνεπάγεται τον αποκλεισμό οποιασδήποτε ευθύνης και εγγύησης εκ μέρους της Somfy.

Ο τεχνικός εγκατάστασης οφείλει να ενημερώνει τους πελάτες του για τις συνθήκες χρήσης και συντήρησης του μηχανισμού, οφείλει δε να τους μεταβιβάζει τις οδηγίες χρήσης και συντήρησης, καθώς επίσης και το συνημμένο έγγραφο **Οδηγίες ασφαλείας**, μετά την εγκατάσταση του μηχανισμού. Για οποιαδήποτε εργασία σέρβις μετά την πώληση στο μηχανισμό απαιτείται η επέμβαση επαγγελματία με γνώσεις στους μηχανισμούς και αυτοματισμούς κατοικιών.

Σε περίπτωση αμφιβολίας κατά την εγκατάσταση του μηχανισμού ή αν επιθυμείτε συμπληρωματικές πληροφορίες, συμβουλευτείτε αρμόδιο άτομο επικοινωνίας της Somfy ή επισκεφθείτε τον ιστότοπο [www.somfy.com](http://www.somfy.com).

### Ειδικές οδηγίες ασφαλείας

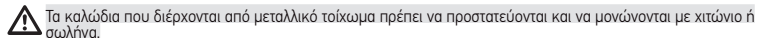
 Τα καλώδια που διέρχονται από μεταλλικό τοίχωμα πρέπει να προστατεύονται και να μονώνονται με πτώινα ή σωλήνα.

 Στερεώστε τα καλώδια προς αποφυγή οποιασδήποτε επαφής με κάποιο κινούμενο εξάρτημα.

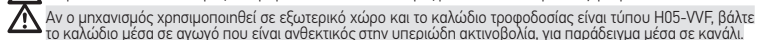
 Αν ο μηχανισμός χρησιμοποιηθεί σε εξωτερικό χώρο και το καλώδιο τροφοδοσίας είναι τύπου H05-VVF, βάλτε το καλώδιο μέσα σε αγωγό που είναι ανθεκτικός στην υπεριώδη ακτινοβολία, για παράδειγμα μέσα σε κανάλι.

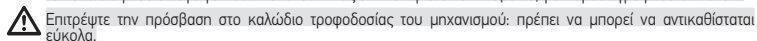
 Επιτρέψτε την πρόσβαση στο καλώδιο τροφοδοσίας του μηχανισμού: πρέπει να μπορεί να αντικαθίσταται εύκολα.

 Κάνετε πάντοτε μια θηλιά στο καλώδιο τροφοδοσίας, για να αποτρέπεται η διείσδυση νερού στο μηχανισμό!

 Για σωληνώτα μωτέρ Ø 50/60 mm:

Ο τροχός πρέπει να ακινητοποιηθεί ως προς τη μετατόπισή του μέσα στο σωλήνα τύλιξης:

- Στερεώστε το σωλήνα τύλιξης στον τροχό τοποθετώντας 4 βίδες ή 4 τυφλά πρωτίνα σε απόσταση από 5 mm έως 15 mm από το εξωτερικό άκρο του τροχού, ανεξάρτητα από το σωλήνα τύλιξης. Οι βίδες ή τα τυφλά πρωτίνα δεν πρέπει να στερεώνονται στο μηχανισμό, αλλά μόνο στον τροχό.

- Είτε με τη χρήση ένα στον τροχού, σε σωληνές που δεν είναι λεία.

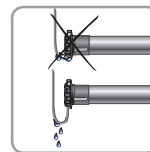





## FR Symboles utilisés dans cette notice

## EN Symbols used in this booklet

## IT Simboli utilizzati in questo manuale

FR - Les actions / EN - Actions / IT - Le azioni

|   |   |   |   |
|---|---|---|---|
|  Montée /<br>my Up /<br>↓ Salita |  Decente /<br>my Down /<br>↓ Discesa |  Arrêt /<br>my Stop /<br>↓ Arresto |   Appui simultané /<br>my Press simultaneously /<br>↓ Pressione contemporanea |
|---|---|---|---|

FR - Temps d'appui /  
EN - Command duration /  
IT - Tempi di pressione

|                                  |  |
|----------------------------------|--|
| <b>2 s</b> ) Maintien minimal /  | } Appui bref /<br>Press briefly /<br>Pressione breve |
| <b>5 s</b> ) Hold down time /    |  |
| <b>7 s</b> ) Mantenimento minimo |  |

FR - État du produit porteur / EN - End-product status / IT - Stato del prodotto contrassegnato



Position basse /  
Low position /  
Posizione bassa



Position haute /  
High position /  
Posizione alta



Montée /  
Up /  
Salita



Arrêt à la position souhaitée /  
Stop at the required position /  
Arresto sulla posizione desiderata



Bref mouvement (bonne réception) /  
Short up & down movement /  
Movimento breve (buona ricezione)



Descente /  
Down /  
Discesa



Position intermédiaire /  
Intermediate position /  
Posizione intermedia



Position médiane /  
Midway position /  
Posizione mediana

— / — /  
Or /  
oppure



Réglage terminé /  
Executed setting /  
Regolazione terminata

# 1

## FR Préparation du tube

## EN Tube preparation

## IT Preparazione del tubo

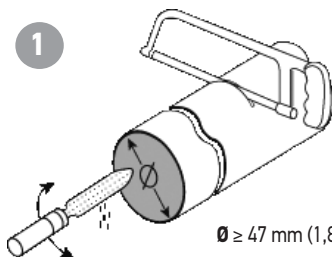

Ø ≥ 47 mm (1,85 in / 1,85 in / 1,85 in)

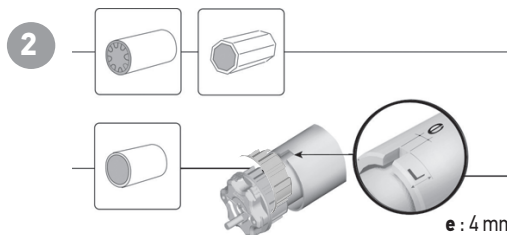

e : 4 mm (0,16 in / 0,16 in / 0,16 in)

L : 28 mm (1,10 in / 1,10 in / 1,10 in)





# MRR RTS

**ES** Símbolos utilizados en este manual

**PT** Símbolos utilizados nestas instruções

**EL** Σύμβολα που χρησιμοποιούνται στο παρόν εγχειρίδιο

**ES - Acciones / PT - As acções / EL - Οι ενέργειες**

|  |   |  |  |
|--|---|--|--|
|  Subida /<br>my Subida /<br>v Άνοδος |  Bajada /<br>my Descida /<br>v Κάθοδος |  Parada /<br>my Desactivação /<br>v Σταμάτημα |   Pulsación simultánea /<br>my Pressão simultânea /<br>v Ταυτόχρονο πάτημα |
|--|---|--|--|

**ES - Tiempo de pulsación / PT - Tempo de pressão / EL - Διάρκεια πατήματος**

|            |   |              |  |
|------------|---|--------------|--|
| <b>2 s</b> | ) Mantenimiento mínimo /<br>Pressão contínua mínima /<br>Ελάχιστο παρατεταμένο πάτημα | <b>0.5 s</b> | Pulsación breve /<br>Pressão breve /<br>Σύντομο πάτημα |
| <b>5 s</b> |   |              |  |
| <b>7 s</b> |   |              |  |

**ES - Estado del elemento móvil / PT - Estado do produto portador / EL - Κατάσταση του φέροντος προϊόντος**

|  |   |   |  |
|--|---|---|--|
|  Posición baja /<br>Posição inferior /<br>Κάτω θέση  |  Posición alta /<br>Posição superior /<br>Επάνω θέση |  Subida /<br>Subida /<br>Άνοδος                                  |  Parada en la posición deseada /<br>Paragem na posição desejada /<br>Ελάχιστο παρατεταμένο πάτημα |
|  Movimiento breve (recepción correcta) /<br>Movimento breve (boa recepção)<br>Σύντομη κίνηση (καλή λήψη) |  Descenso /<br>Descida /<br>Κάθοδος                  |  Posición intermedia /<br>Posição intermédia /<br>Ενδιάμεση θέση |  Posición intermedia alta / Posição média /<br>Μεσαία θέση                                       |

--- 0 /  
Ou /  
H

 Ajuste terminado /  
Regulação terminada /  
Ολοκλήρωση ρύθμισης

**1**

**ES** Preparación del tubo

**PT** Preparação do tubo de enrolamento

**EL** Προετοιμασία του σωλήνα

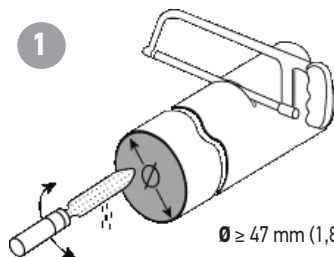

$\varnothing \geq 47 \text{ mm}$  (1,85 in / 1,85 in / 1,85 in)

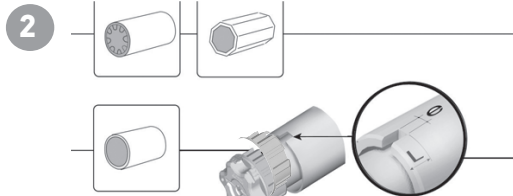

**e** : 4 mm (0,16 in / 0,16 in / 0,16 in)  
**L** : 28 mm (1,10 in / 1,10 in / 1,10 in)

2

## FR Assemblage du moteur

## EN Motor mounting

## IT Assemblaggio del motore

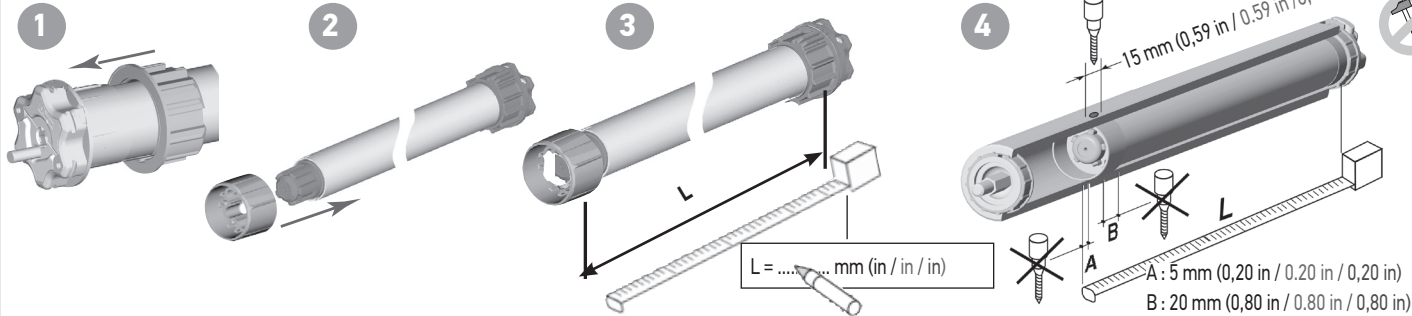

3

## FR Installer le tube sur ses supports

## EN Install the tube on the brackets

## IT Montare il tubo sui propri supporti

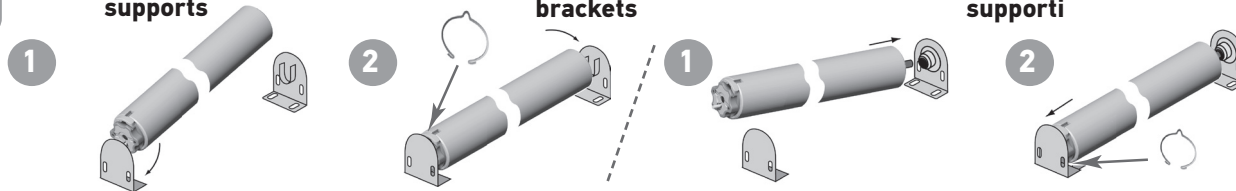

4

## FR Alimentation et câblage

## EN Power supply and wiring

## IT Alimentazione e cablaggio

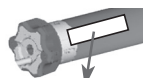

Vérifier /  
Check /  
Controllare

| 1                              | 2                               | 3  |
|--------------------------------|---------------------------------|--|
| Phase /<br>Live /<br>Fase      | Neutre /<br>Neutral /<br>Neutro | Terre /<br>Earth /<br>Terra                    |
| Marron /<br>Brown /<br>Marrone | Bleu /<br>Blue /<br>Blu         | Vert-jaune /<br>Green-yellow /<br>Verde-giallo |

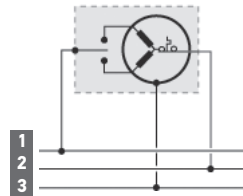

Alimenter /  
Supply /  
Alimentare

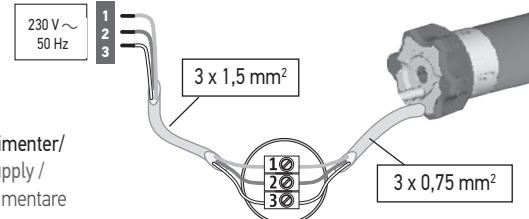

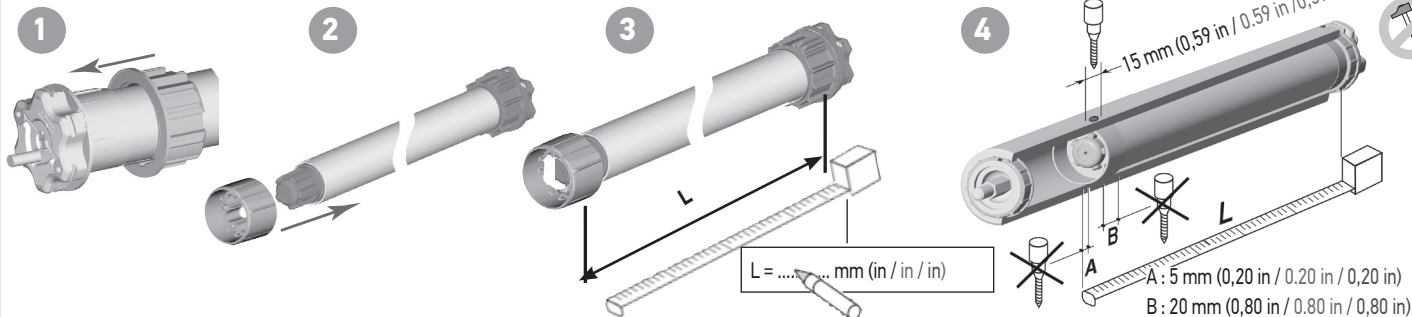
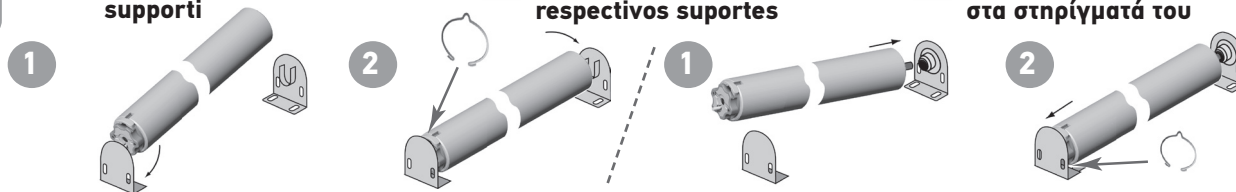
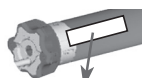
**2****ES** Assemblaggio del motore**PT** Montagem do motor**EL** Συναρμολόγηση του μοτέρ**3****ES** Montare il tubo sui propri supporti**PT** Instalar o tubo nos respectivos suportes**EL** Εγκατάσταση του σωλήνα στα στηρίγματά του**4****ES** Alimentazione e cablaggio**PT** Alimentação e cablagem**EL** Τροφοδοσία και καλωδίωση

Controllare /  
Verificar /  
Ελέγξτε

| 1                               | 2                                 | 3  |
|---------------------------------|-----------------------------------|--|
| Fase /<br>Fase /<br>Φάση        | Neutro /<br>Neutro /<br>Ουδέτερος | Terra /<br>Terra /<br>Γείωση                         |
| Marrone /<br>Castanho /<br>Καφέ | Blu /<br>Azul /<br>Μπλε           | Verde-giallo /<br>Verde/Amarelo /<br>Πράσινο-Κίτρινο |

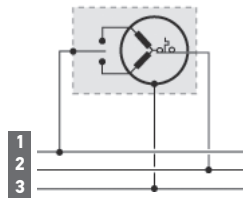

Alimentare /  
Alimentar /  
Τροφοδοσία

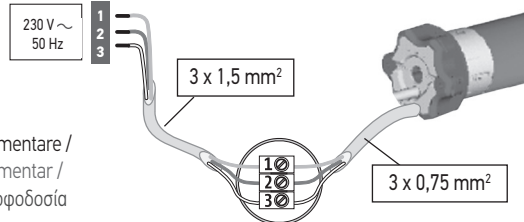

## 5

**FR** Programmation du sens de rotation**EN** Programming the direction of rotation**IT** Programmazione del senso di rotazione

Si l'installation comporte plusieurs MRR RTS, un seul moteur MRR RTS doit être alimenté pendant la phase de programmation. Ceci évitera les interférences avec les autres moteurs MRR RT lors de la première programmation.



If the installation is made up of several MRR RTS, only one MRR RTS motor must be powered during programming. This will avoid interference with the first programming of each MRR RTS motor.



Se l'installazione interessa diversi MRR RTS, solo uno motore MRR RTS deve essere alimentato durante la fase di programmazione. Questo eviterà le interferenze con gli altri motori MRR RTS al momento della prima programmazione.



2 s

## 6

**FR** Réglage des fins de course**EN** End limits adjustment**IT** Regolazione dei fincorsa

0,5 s



0,5 s



0,5 s



0,5 s



2 s



0,5 s



0,5 s



0,5 s





# 5

## ES Programación del sentido de rotación

## PT Programação do sentido de rotação

## EL Προγραμματισμός της φοράς περιστροφής

⚠ Si la instalación incluye varios MRR RTS, debe proporcionarse alimentación a un solo motor MRR RTS durante la fase de programación. De esta forma se evitarán las interferencias con los demás motores MRR RTS durante la primera programación.

⚠ Se a instalação tiver vários MRR RTS, apenas um motor MRR RTS deve ser alimentado durante a fase de programação. Desta forma, serão evitadas interferências com os outros motores MRR RTS aquando da primeira programação.

⚠ Αν η εγκατάσταση διαθέτει πολλά MRR RTS, ένα μόνο μοτέρ MRR RTS πρέπει να τροφοδοτείται με ρεύμα κατά τη φάση του προγραμματισμού. Έτσι αποτρέπονται παρεμβολές με άλλα μοτέρ MRR RTS κατά τον πρώτο προγραμματισμό.

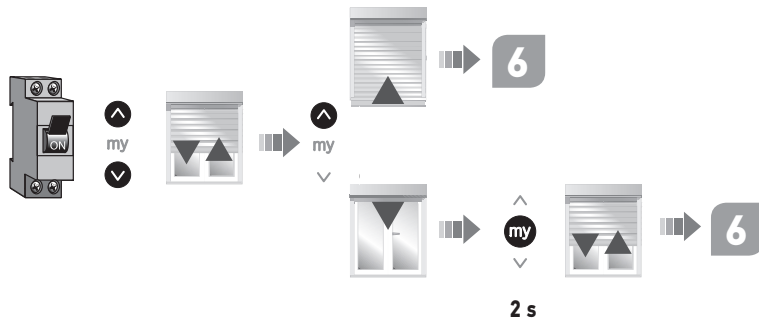

# 6

## ES Ajuste de los finales de carrera

## PT Regulação dos fins de curso

## EL Ρύθμιση των τερματικών διακοπών

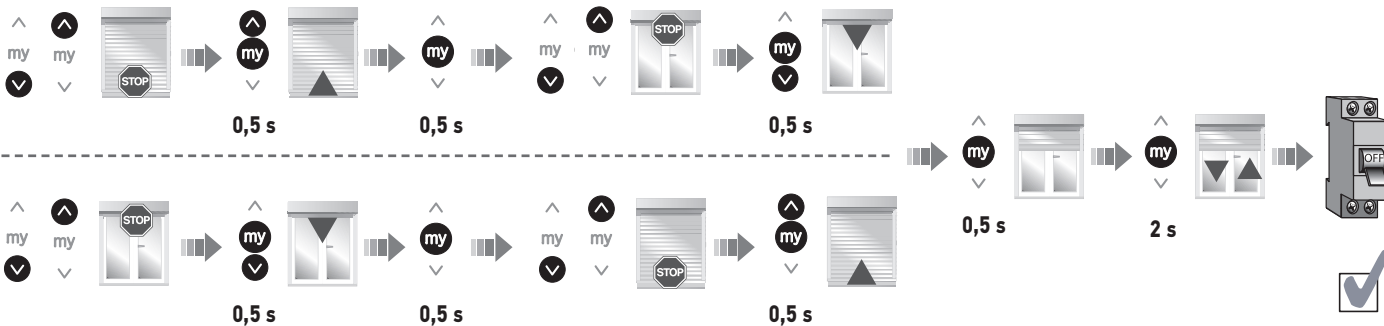

7

**FR** Enregistrement du premier émetteur

**EN** Programming the first transmitter

**IT** Programmazione del primo trasmettitore

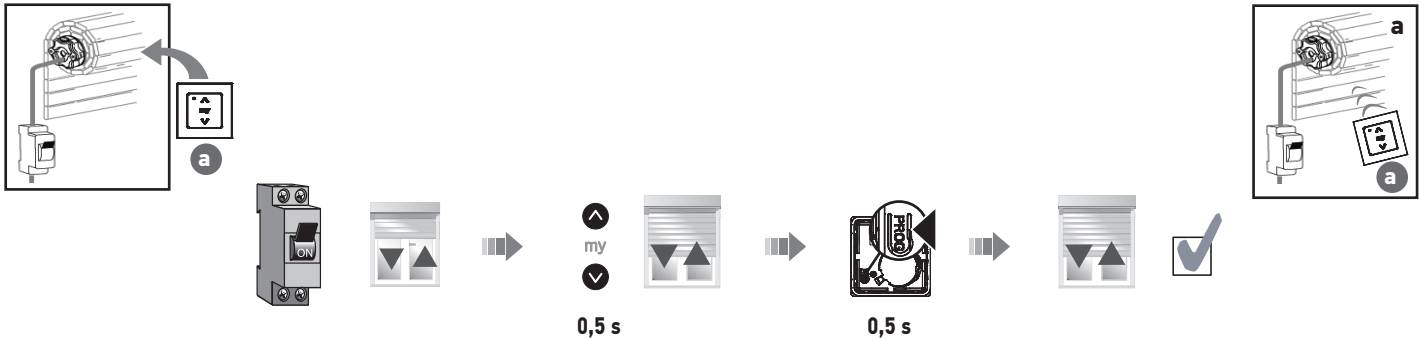

8

**FR** Enregistrement ou modification de la position intermédiaire

**EN** Recording or changing intermediate position

**IT** Salvataggio o modifica della posizione intermedia

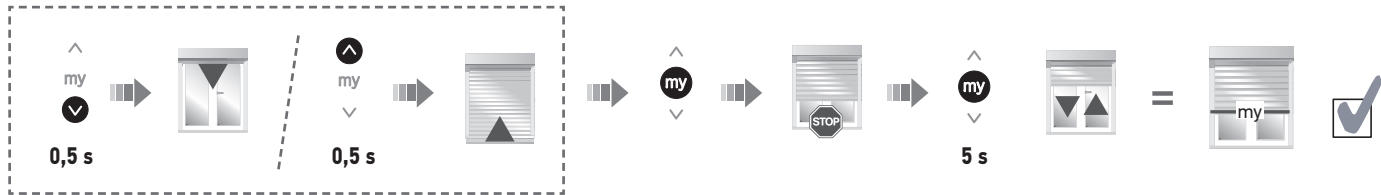

# 7

**ES** Memorización del primer emisor

**PT** Registo do primeiro emissor

**EL** Καταχώριση του πρώτου πομπού



# 8

**ES** Memorización o modificación de la posición intermedia

**PT** Registo ou modificação da posição intermédia

**EL** Αποθήκευση ή τροποποίηση της ενδιάμεσης θέσης

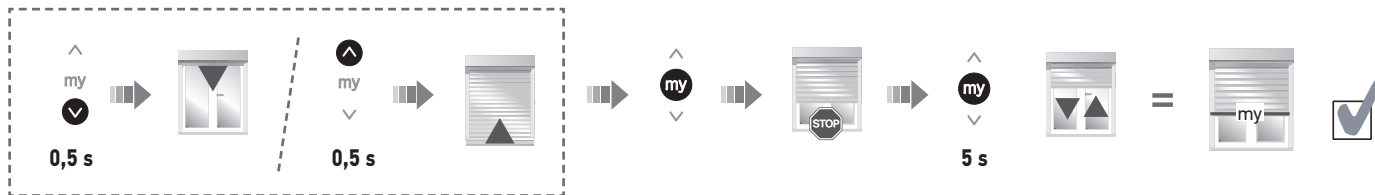

**FR** Commander la position intermédiaire

**EN** Intermediate position control

**IT** Comandare la posizione intermedia



**FR** Suppression de la position intermédiaire

**EN** Delete an intermediate position

**IT** Eliminazione della posizione intermedia

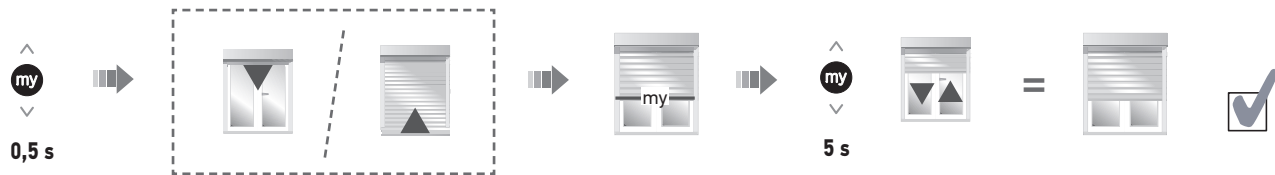

**ES** Control de la posición intermedia

**PT** Comandar a posição intermédia

**EL** Εντολή μετάβασης στην ενδιάμεση θέση



**ES** Eliminación de la posición intermedia

**PT** Eliminação da posição intermédia

**EL** Διαγραφή της ενδιάμεσης θέσης

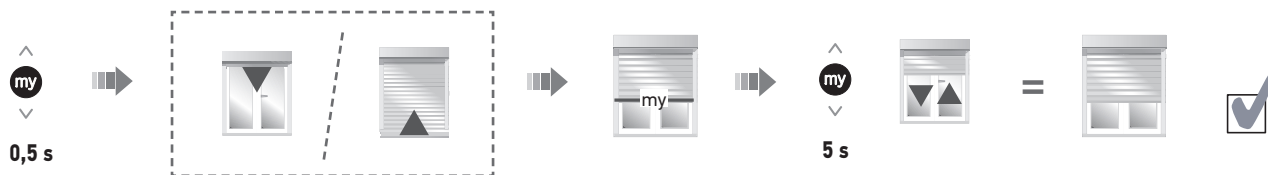

9

**FR** Ajout d'un émetteur dans la mémoire moteur

**EN** Add a control in the memory of motor

**IT** Aggiunta di un trasmettitore nella memoria motore

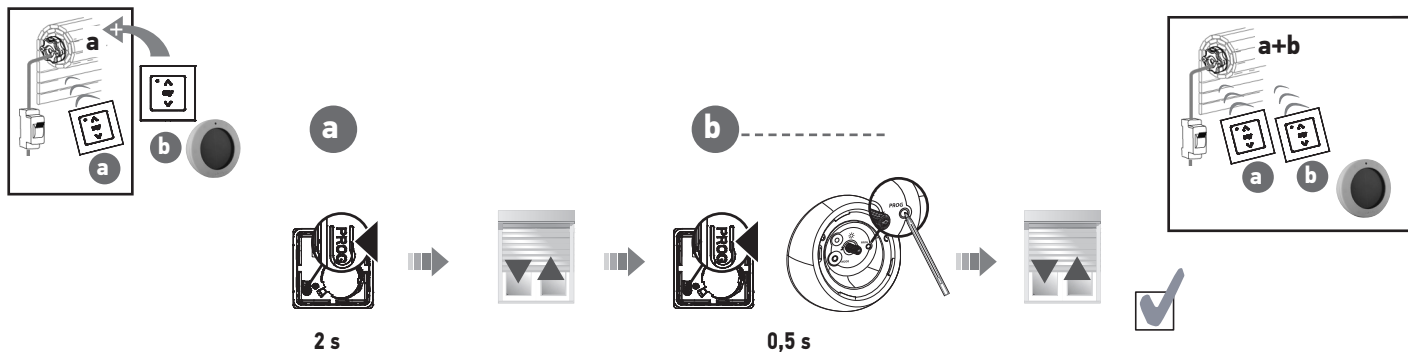

**FR** Suppression d'un émetteur dans la mémoire moteur

**EN** Delete a control in the memory of motor

**IT** Cancellazione di un trasmettitore nella memoria motore

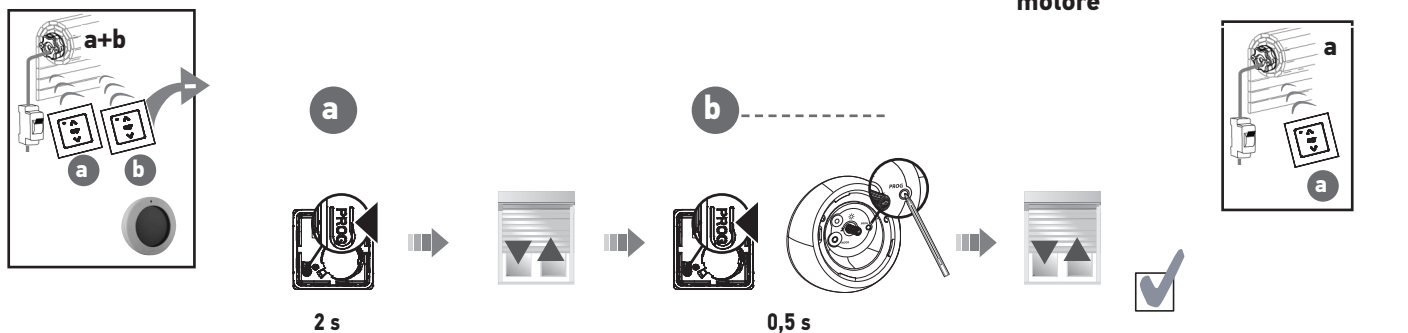

**ES** Adición de un emisor a la memoria del motor

**PT** Adição de um emissor na memória do motor

**EL** Προσθήκη πομπού στη μνήμη του μοτέρ

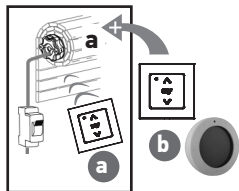

2 s



0,5 s

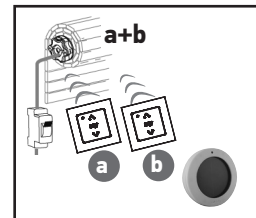
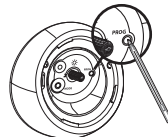

**ES** Eliminación de un emisor de la memoria del motor

**PT** Eliminação de um emissor na memória do motor

**EL** Διαγραφή πομπού από τη μνήμη του μοτέρ

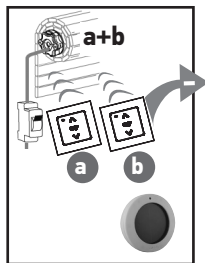

2 s



0,5 s

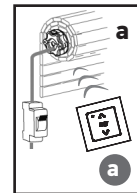
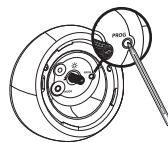

10

### FR Remplacement d'un émetteur perdu

### EN Replacement of a lost remote control

### IT Sostituzione di un trasmettitore perso

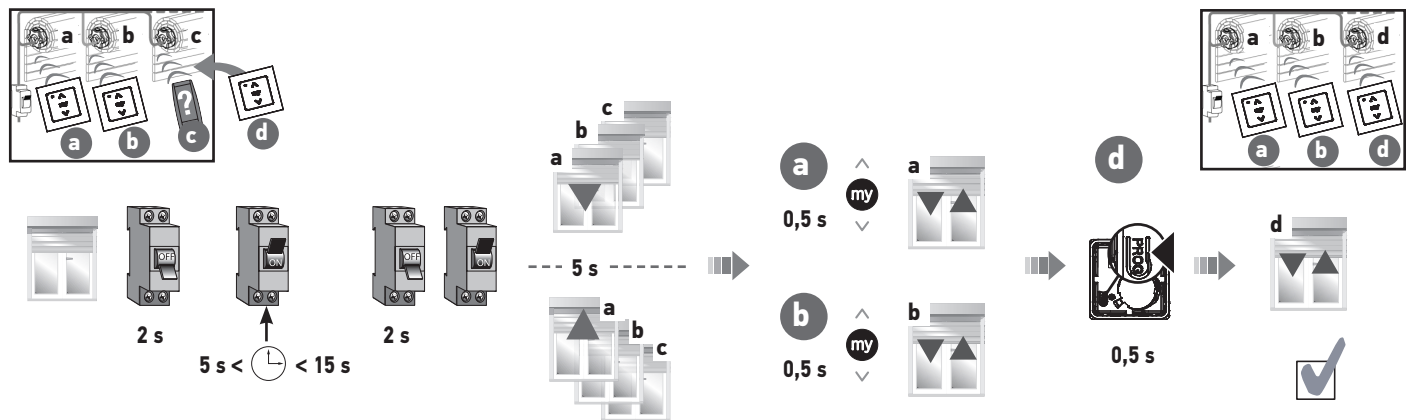
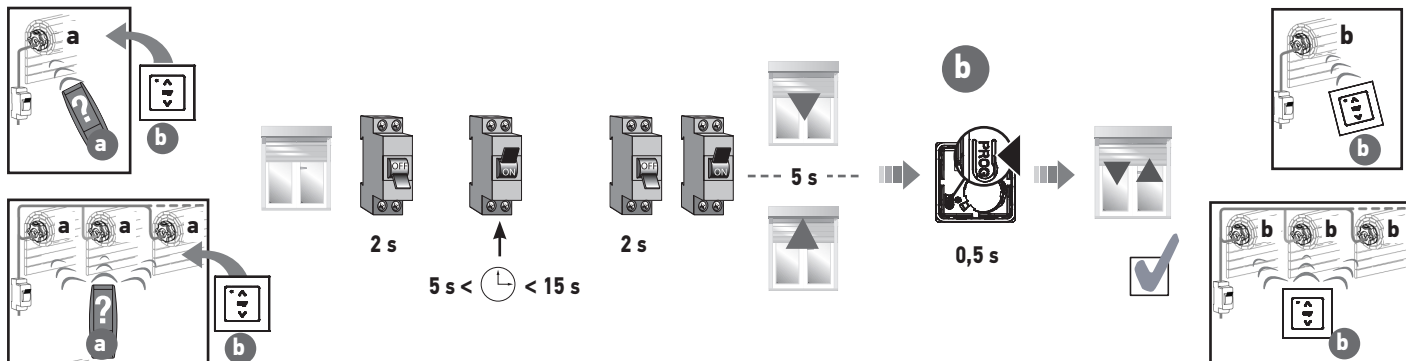



**ES** Sustitución de un emisor perdido

**PT** Substituição de um emissor perdido

**EL** Αντικατάσταση χαμένου πομπού

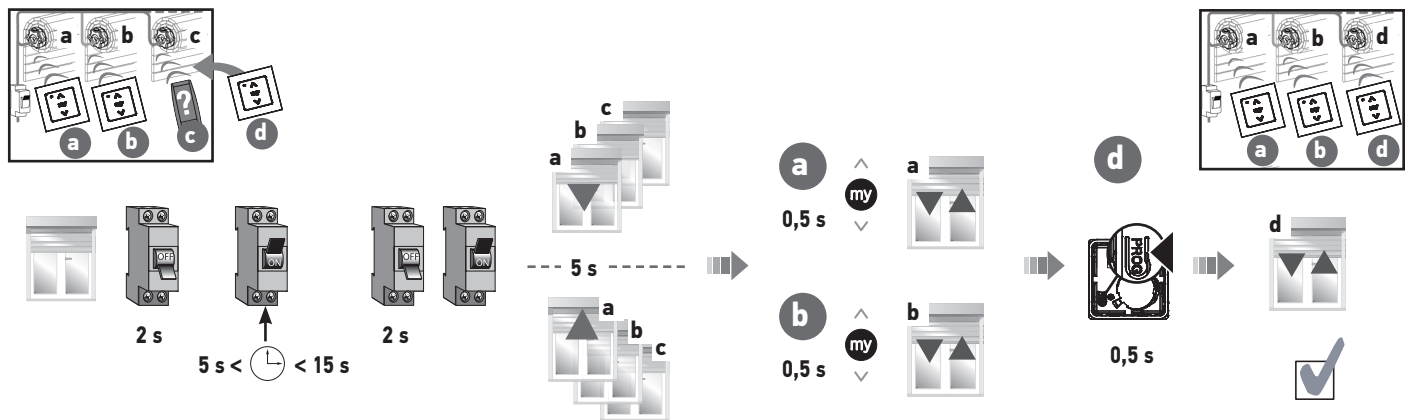
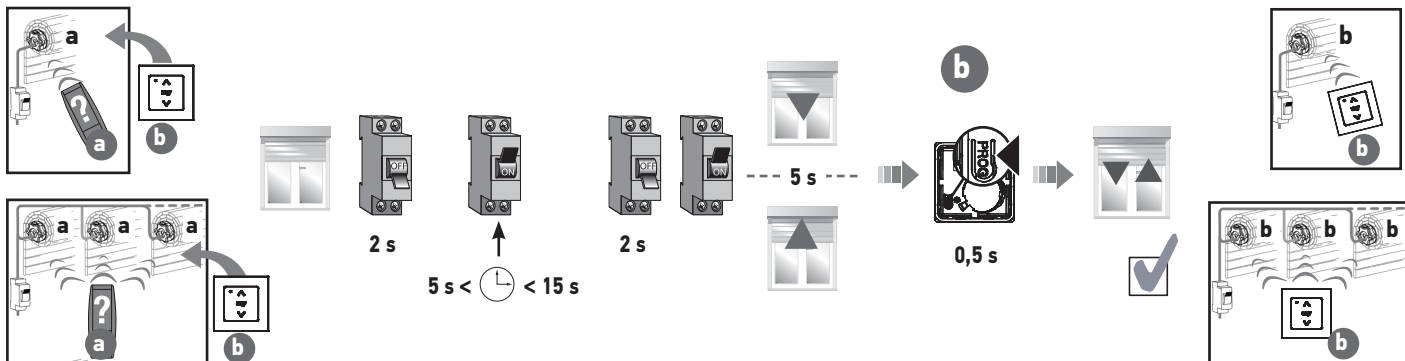

11

## FR Effacement complet de la mémoire moteur

## EN Erase the memory of motor

## IT Cancellazione completa della memoria motore

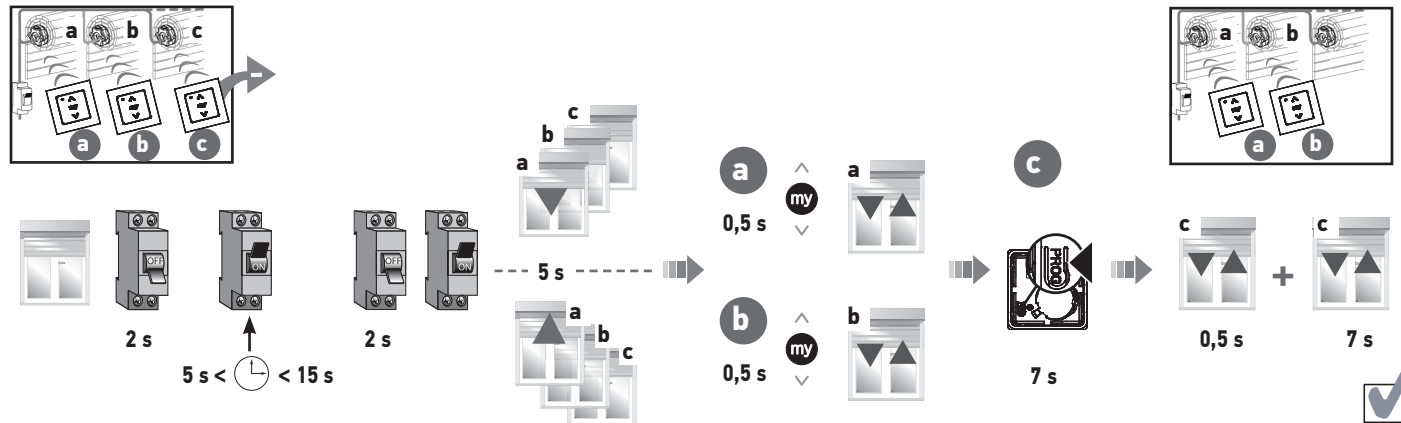
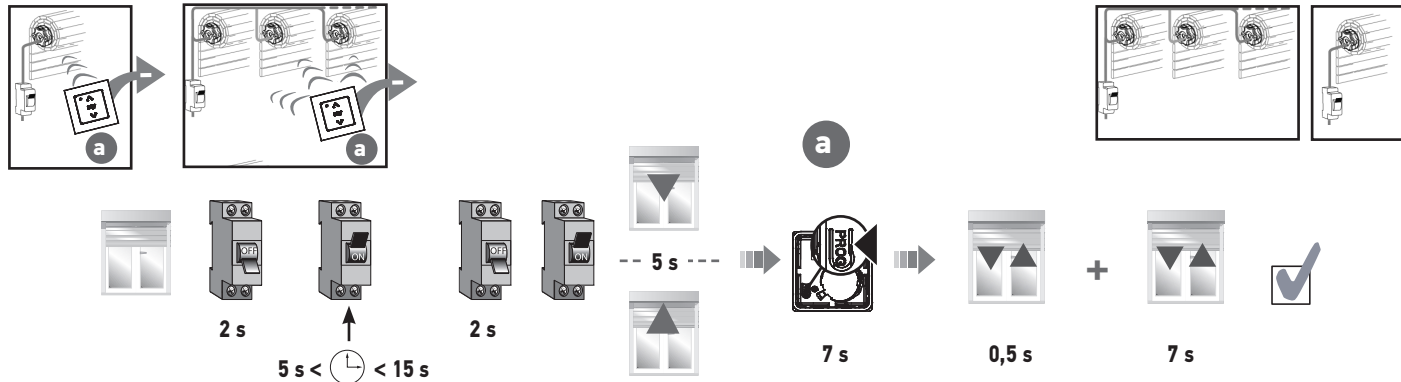

# 11

## ES Borrado completo de la memoria del motor

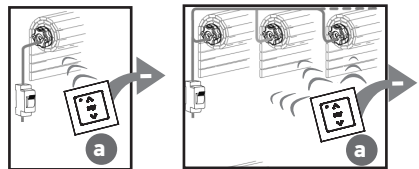

2 s



5 s <  < 15 s

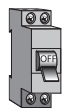

2 s



5 s

**a**



7 s

## EL Πλήρης διαγραφή της μνήμης μοτέρ

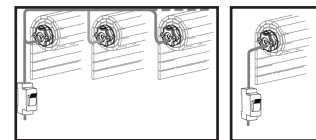

0,5 s



7 s

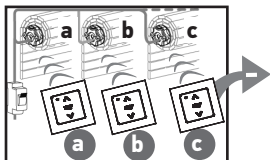

2 s



5 s <  < 15 s

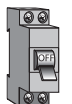

2 s

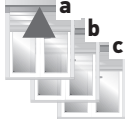

a

b

c

a

b

c

5 s

**a**

0,5 s

^

my

v



**b**

0,5 s

^

my

v



**c**



7 s

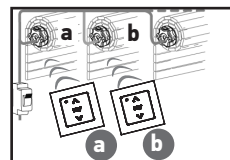

0,5 s



7 s



12

**FR Réajustement des fins de course**

**FR - Réglage limite haute /**  
**EN - Up limit adjustment /**  
**IT - Regolazione limite alto**

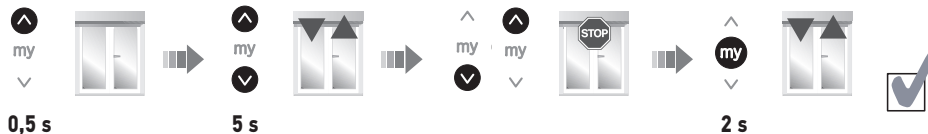

**FR - Réglage limite basse /**  
**EN - Down limit adjustment /**  
**IT - Regolazione limite basso**

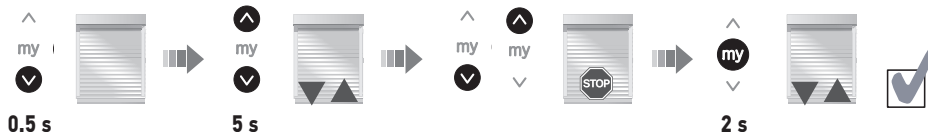
**FR Dépannage****Le moteur ne fonctionne pas:****Vérifier:**

- le câblage du moteur
- le contact thermique (attendre le refroidissement du moteur)
- la pile de la télécommande
- la compatibilité des télécommandes
- la bonne mémorisation de la télécommande par le moteur
- l'absence d'interférences radio.

**L'appareillage s'arrête trop tôt:****Vérifier:**

- que la couronne d'entraînement est bien solidarisée au tube
- que les fins de course du moteur sont bien réglées.

**EN Trouble shooting****The motor doesn't work:****Verify:**

- the wiring of motor
- the heat generated (wait for the cooling of motor)
- the battery of the remote control
- the compatibility of remote control
- the control is properly programmed into the memory of the motor
- there is no interference from other radio equipment.

**The equipment stops too soon:****Verify:**

- the crown is properly fitted to the tube
- the end-limits of motor are properly adjusted.

**IT Manutenzione****Il motore non funziona:****Controllare:**

- il cablaggio del motore
- il contatto termico (attendere che il motore si raffreddi)
- la pila del trasmettitore
- la compatibilità dei trasmettitori
- la memorizzazione corretta del telecomando da parte del motore
- l'assenza di interferenze radio.

**L'apparecchiatura si arresta troppo presto:****Controllare:**

- che la corona di trasmissione sia collegata saldamente al tubo
- che i fincorsa del motore siano impostati correttamente.

**ES** Reajuste de los finales de carrera

*ES - Ajuste del límite superior /  
PT - Regulação do limite superior /  
EL - Ρύθμιση επάνω ορίου*



my



0,5 s



my



5 s



my



my



my



2 s



*ES - Ajuste del límite inferior /  
PT - Regulação do limite inferior /  
EL - Ρύθμιση κάτω ορίου*



my



0,5 s



my



5 s



my



my



my



2 s

**ES** Reparación**El motor no funciona.****Compruebe:**

- el cableado del motor;
- el contacto térmico (espere a que se enfríe el motor);
- la pila del mando a distancia;
- la compatibilidad de los mandos a distancia;
- la memorización correcta del mando a distancia por parte del motor;
- la ausencia de interferencias de radio.

**El equipo se detiene demasiado pronto.****Compruebe:**

- que la corona de arrastre esté solidarizada correctamente al tubo;
- que los finales de carrera del motor estén ajustados correctamente.

**PT** Desempanagem**O motor não trabalha:****Verificar:**

- a cablagem do motor
- o contacto térmico (aguardar pelo arrefecimento do motor)
- a pilha do comando à distância
- a compatibilidade dos comandos à distância
- a correcta memorização do comando à distância pelo motor
- a ausência de interferências rádio.

**O aparelho pára demasiado cedo:****Verificar:**

- que a coroa de tracção está correctamente ligada ao tubo
- que os fins de curso do motor estão bem regulados.

**EL** Επίλυση προβλημάτων**Το μοτέρ δεν λειτουργεί:****Ελέγξτε:**

- την καλωδίωση του μοτέρ
- τη θερμική προστασία (περιμένετε να κρυώσει το μοτέρ)
- την μπαταρία του τηλεχειριστηρίου
- τη συμβατότητα των τηλεχειριστηρίων
- τη σωστή απομνημόνευση του τηλεχειριστηρίου από το μοτέρ
- την απουσία παρεμβολών.

**Το προϊόν σταματά πολύ νωρίς:****Ελέγξτε:**

- ότι η κορώνα μετάδοσης κίνησης είναι καλά στερεωμένη στο σωλήνα
- ότι οι τερματικοί διακόπτες του μοτέρ είναι ρυθμισμένοι σωστά.

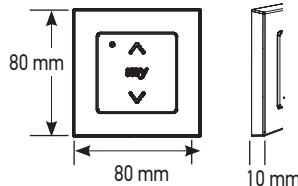
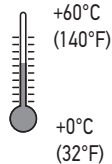
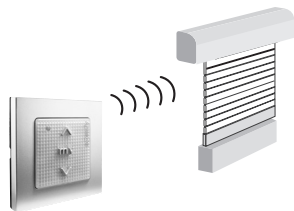

Radio Technology Somfy™

433,42 MHz

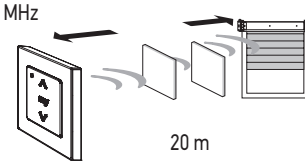

## FR Ajout ou suppression d'un émetteur

À l'aide d'un émetteur mémorisé

## EN Add or delete a control

With help of a recorded control

## IT Aggiunta o cancellazione di un trasmettitore

Tramite un trasmettitore memorizzato

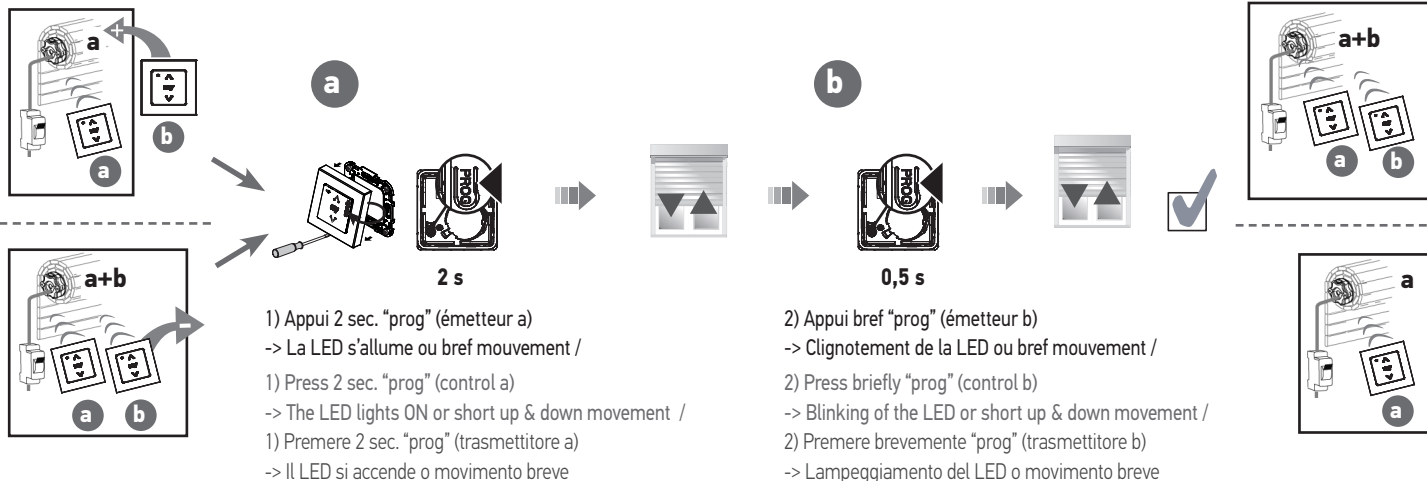

- 1) Appui 2 sec. "prog" (émetteur a)
- > La LED s'allume ou bref mouvement /
- 1) Press 2 sec. "prog" (control a)
- > The LED lights ON or short up & down movement /
- 1) Premere 2 sec. "prog" (trasmettitore a)
- > Il LED si accende o movimento breve

- 2) Appui bref "prog" (émetteur b)
- > Clignotement de la LED ou bref mouvement /
- 2) Press briefly "prog" (control b)
- > Blinking of the LED or short up & down movement /
- 2) Premere brevemente "prog" (trasmettitore b)
- > Lampeggiamento del LED o movimento breve

# Smooove Origin RTS

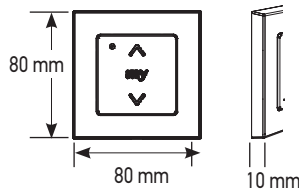
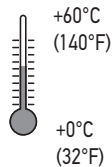
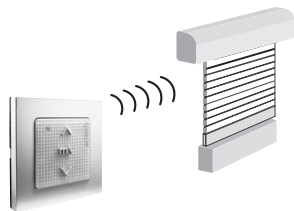

Radio Technology Somfy™

433,42 MHz

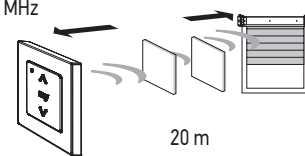

## ES Adición o eliminación de un emisor

Con un emisor memorizado

## PT Adição ou eliminação de um emissor

Com o auxílio de um emissor memorizado

## EL Προσθήκη ή κατάργηση πομπού

Με τη βοήθεια απομνημονευμένου πομπού

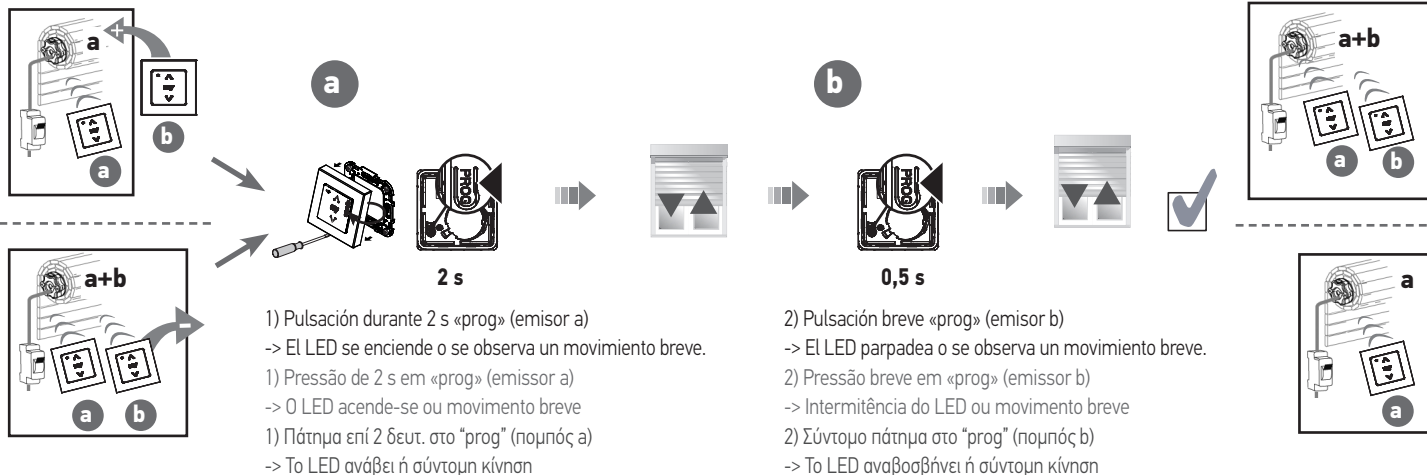

**FR** Utilisation des télécommandes

**EN** Using hand-held transmitters

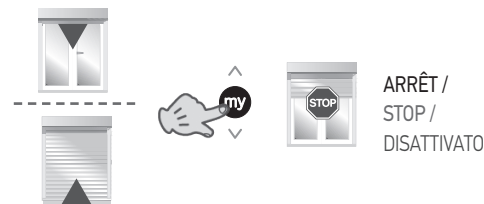
**IT** Utilizzo dei trasmettitori

**FR - Position favorite (my) / EN - Intermediate position (my) / IT - Posizione preferita (my)**

**Enregistrement ou modification :** arrêt à la position souhaitée puis appui 5 sec. sur "my" /

**Recording or changing :** stop at the required position and press 5 sec. "my" /

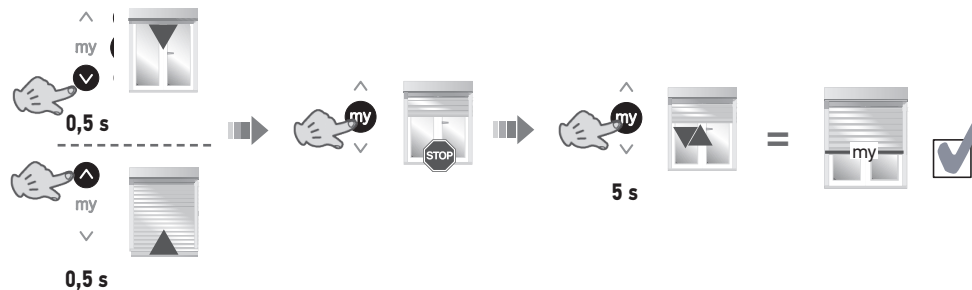
**Programmazione o modifica :** arrestare nella posizione desiderata quindi tenere premuto 5 sec. "my"



**Utilisation :** Appui bref sur "my" /

**Using :** Press briefly "my" /

**Utilizzo :** premere brevemente il tasto "my"

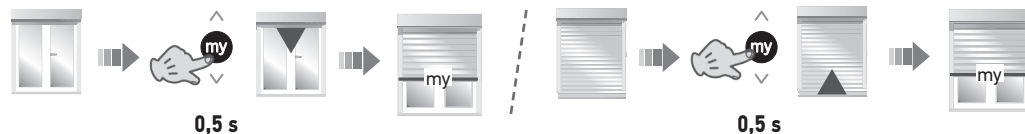

**Suppression :** Appui 5 sec. sur "my" /

**Deleting :** press 5 sec. "my" /

**Cancellazione :** Premere 5 sec. su "my"





**ES** Utilización de los  
telemandos



**PT** Utilização dos comandos à  
distância



**EL** Χρήση των  
τηλεχειριστηρίων



**ES - Posición favorita ("My") / PT - Posição preferida («my») / EL - Αγαπημένη θέση (my)**

**Memorización o modificación:** parada en la posición deseada y, a continuación, pulsación de «my» durante 5 s

**Registo ou modificação:** paragem na posição desejada e depois pressão de 5 s em «my»

**Αποθήκευση ή τροποποίηση :** σταμάτημα στην επιθυμητή θέση και μετά πάτημα επί 5 δευτ. στο "my"

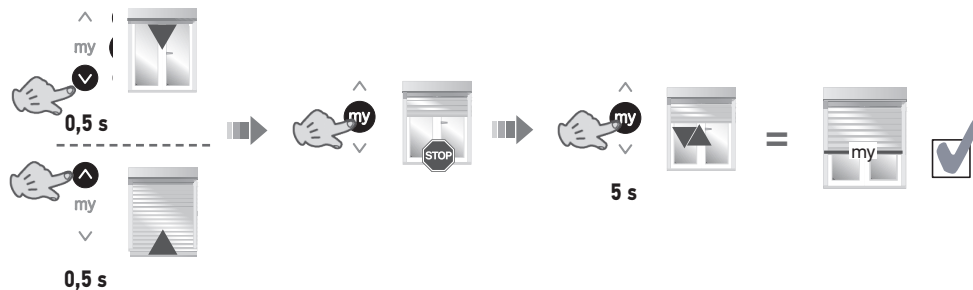

**Uso:** pulsación breve de «my»

**Utilização:** Pressão breve em «my» /

**Χρήση:** Σύντομο πάτημα στο "my"



**Eliminación:** pulsación de «my» durante 5 s /

**Eliminação:** Pressão de 5 s em «my» /

**Κατάργηση:** Πάτημα επί 5 δευτ. στο "my"



**FR** Installation

1

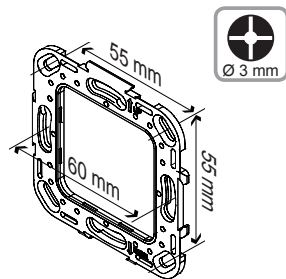
**EN** Installation

2

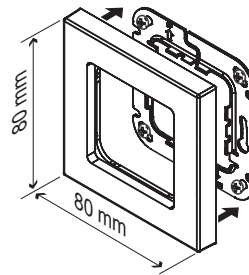
**IT** Installazione

3

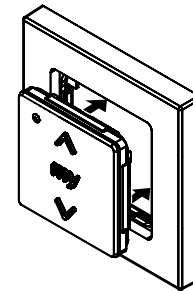

**ES** Instalación

**PT** Instalação

**EL** Εγκατάσταση

1

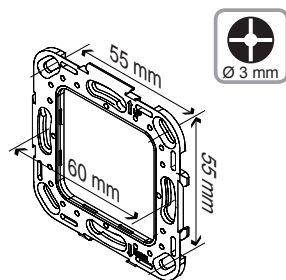

2

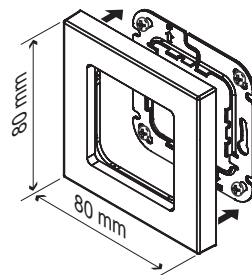

3

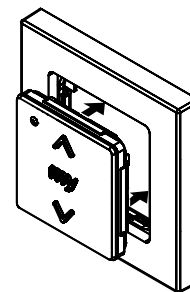

**FR Remplacement de la pile****EN Replacing the battery****IT Sostituzione della batteria**

1

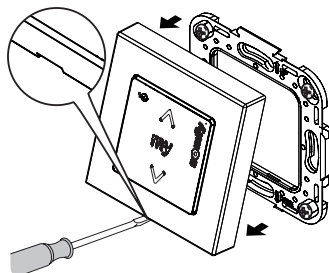

2

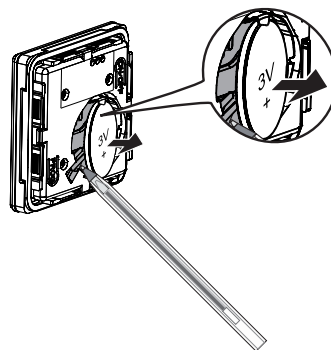

3 V type CR 2430

3

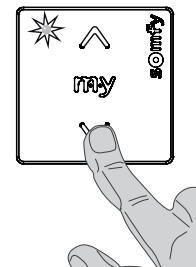

Veiller à séparer les piles et batteries des autres types de déchets et à les recycler via le système local de collecte.

Please separate the storage cells and batteries from other types of waste and recycle them via the local collection facility.

Le batterie o gli accumulatori devono essere separati dagli altri tipi di rifiuti e riciclati tramite l'apposito centro di raccolta.

## ES Cambio de la pila

## PT Substituição da pilha

## EL Αντικατάσταση της μπαταρίας

1

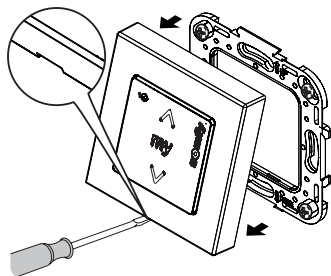

2

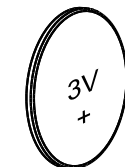
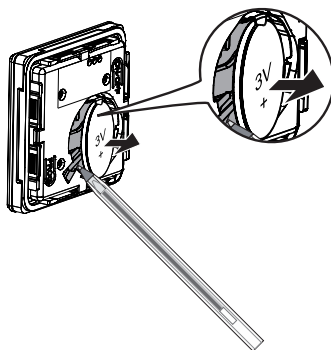

3 V type CR 2430

3

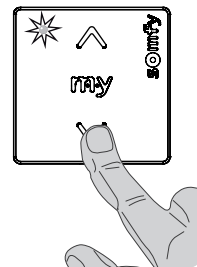

Recuerde separar las baterías y las pilas del resto de desechos y reciclarlas a través del centro de recogida de residuos de la localidad.

As baterias e os acumuladores têm de ser separados de outros tipos de resíduos e têm de ser reciclados através de sistemas de tratamento e reciclagem locais.

Οι μπαταρίες ή οι συσσωρευτές πρέπει να διαχωρίζονται από τους άλλους τύπους απορριμμάτων και να προσκομίζονται για ανακύκλωση στην τοπική υπηρεσία συλλογής απορριμμάτων.

**CE** Par la présente, SOMFY ACTIVITES SA, F-74300 CLUSES déclare en tant que fabricant que la motorisation couverte par ces instructions, marquée pour être alimentée en 230V-50Hz et utilisée comme indiqué dans ces instructions, est conforme aux exigences essentielles des Directives Européennes applicables et en particulier de la Directive Machine 2006/42/EC et de la Directive Radio 2014/53/EU. Le texte complet de la déclaration de conformité à l'UE est disponible sur [www.somfy.com/ce](http://www.somfy.com/ce).  
Antoine CREZE, responsable des homologations, agissant au nom du Directeur de l'Activité, Cluses, 04/2016.

**CE** SOMFY ACTIVITES SA, F-74300 CLUSES as manufacturer hereby declares that the drive covered by these instructions when marked for input voltage 230V-50Hz and used as intended according to these instructions, is in compliance with the essential requirements of the applicable European Directives and in particular of the Machinery Directive 2006/42/EC, and the Radio Directive 2014/53/EU. The full text of the EU declaration of conformity is available at [www.somfy.com/ce](http://www.somfy.com/ce).  
Antoine CREZE, Approval manager, acting on behalf of Activity director, Cluses, 04/2016.

**CE** Con la presente, SOMFY ACTIVITES SA, F-74300 CLUSES dichiara, in qualità di produttore, che la motorizzazione coperta da queste istruzioni, contrassegnata per essere alimentata a 230V-50Hz e per essere utilizzata come indicato nelle presenti istruzioni, è conforme ai requisiti essenziali delle Direttive Europee applicabili e, in particolare, della Direttiva Macchina 2006/42/CE e della Direttiva Radio 2014/53/UE. Il testo completo della dichiarazione di conformità all'UE è disponibile all'indirizzo Internet [www.somfy.com/ce](http://www.somfy.com/ce).  
Antoine CREZE, responsabile delle omologazioni, che agisce per conto del Direttore dell'Attività, Cluses, 04/2016.

**CE** En virtud del presente documento, SOMFY ACTIVITES SA, F-74300 CLUSES declara que, en tanto que fabricante de la motorización que cubren estas instrucciones, marcada para recibir alimentación a 230 V-50 Hz y utilizada tal y como se indica en las mismas, es conforme a las exigencias básicas de las Directivas europeas aplicables y, en particular, la Directiva de máquinas 2006/42/CE y la Directiva de radio 2014/53/UE. El texto completo de la declaración de conformidad en la UE se encuentra disponible en [www.somfy.com/ce](http://www.somfy.com/ce).  
Antoine CREZE, responsable de homologaciones, en representación del director de la actividad, Cluses, 04/2016.

**CE** Pela presente, a SOMFY ACTIVITES SA, F-74300 CLUSES declara que o motor abrangido por estas instruções, marcado para ser alimentado a 230V-50Hz e utilizado como indicado nas mesmas, está conforme as exigências essenciais das Directivas Europeias aplicáveis e, em particular, da Directiva de Máquinas 2006/42/CE e da Directiva de Equipamentos de Rádio 2014/53/UE. O texto completo da declaração de conformidade da UE está disponível em [www.somfy.com/ce](http://www.somfy.com/ce).  
Antoine CREZE, responsável pelas homologações, agindo em nome do Director da Actividade, Cluses, 04/2016.

**CE** Με την παρούσα, η SOMFY ACTIVITES SA, F-74300 CLUSES δηλώνει ως κατασκευαστής ότι ο μηχανισμός που καλύπτεται από αυτές τις οδηγίες, εφόσον φέρει σήμανση για τροφοδοσία 230V-50Hz και χρησιμοποιείται με τον τρόπο που υποδεικνύεται στις παρούσες οδηγίες, συμμορφώνεται με τις ουσιαστικές απαιτήσεις των εφαρμοζόμενων ευρωπαϊκών οδηγιών και ειδικότερα με την οδηγία 2006/42/EK για τις μηχανές και την οδηγία 2014/53/EE για το ραδιοεξοπλισμό. Το πλήρες κείμενο της δήλωσης συμμόρφωσης με την ΕΕ διατίθεται στην ιστοσελίδα [www.somfy.com/ce](http://www.somfy.com/ce).  
O Antoine CREZE, υπεύθυνος εγκρίσεων, ο οποίος ενεργεί για λογαριασμό του Διευθυντή Τομέα, Cluses, 04/2016.

## SOMFY ACTIVITES SA

50 avenue du Nouveau Monde

F - 74300 CLUSES

[www.somfy.com](http://www.somfy.com)

**somfy**